

Compact Disc Player

Operating Instructions



CDP-XE570
CDP-XE370
CDP-XE270

WARNING

To prevent fire or shock hazard, do not expose the unit to rain or moisture.

To avoid electrical shock, do not open the cabinet. Refer servicing to qualified personnel only.

For the customers in the United States

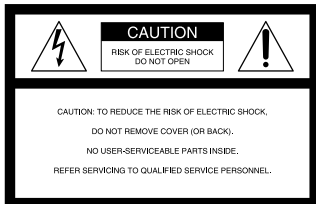

This symbol is intended to alert the user to the presence of uninsulated “dangerous voltage” within the product’s enclosure that may be of sufficient magnitude to constitute a risk of electric shock to persons.



This symbol is intended to alert the user to the presence of important operating and maintenance (servicing) instructions in the literature accompanying the appliance.

INFORMATION

This equipment has been tested and found to comply with the limits for a Class B digital device, pursuant to Part 15 of the FCC Rules. These limits are designed to provide reasonable protection against harmful interference in a residential installation. This equipment generates, uses, and can radiate radio frequency energy and, if not installed and used in accordance with the instructions, may cause harmful interference to radio communications. However, there is no guarantee that interference will not occur in a particular installation. If this equipment does cause harmful interference to radio or television reception, which can be determined by turning the equipment off and on, the user is encouraged to try to correct the interference by one or more of the following measures:

- Reorient or relocate the receiving antenna.
- Increase the separation between the equipment and receiver.
- Connect the equipment into an outlet on a circuit different from that to which the receiver is connected.
- Consult the dealer or an experienced radio/TV technician for help.

CAUTION

You are cautioned that any changes or modification not expressly approved in this manual could void your authority to operate this equipment.

Owner’s Record

The model and serial numbers are located at the rear of the unit.

Record the serial number in the space provided below. Refer to them whenever you call upon your Sony dealer regarding this product.

Model No. _____

Serial No. _____

Except for customers in the United States

This appliance is classified as a CLASS 1 LASER product.

The CLASS 1 LASER PRODUCT MARKING is located on the rear exterior.

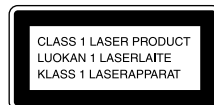

AC power cord must be changed only at the qualified service shop.

Do not install the appliance in a confined space, such as a bookcase or built-in cabinet.

To prevent fire, do not cover the ventilation of the apparatus with news papers, table-cloths, curtains, etc. And don’t place lighted candles on the apparatus.

To prevent fire or shock hazard, do not place vases on the apparatus.



Don’t throw a battery, dispose it as the injurious wastes.

This Class A digital apparatus complies with Canadian ICES-003.

CAUTION

TO PREVENT ELECTRIC SHOCK, DO NOT USE THIS POLARIZED AC PLUG WITH AN EXTENSION CORD, RECEPTACLE OR OTHER OUTLET UNLESS THE BLADES CAN BE FULLY INSERTED TO PREVENT BLADE EXPOSURE.

About this manual

The instructions in this manual are for CDP-XE570, CDP-XE370, and CDP-XE270. CDP-XE570 is the model used for illustration purposes only. Any difference in operation is clearly indicated in the text, for example, “CDP-XE570 only.”

Tip

Instructions in this manual describe the controls on the player.

You can also use the controls on the remote if they have the same or similar names as those on the player (CDP-XE570/XE370 only).

Table of Contents

Parts Identification 4

Front Panel	4
Rear Panel	5
Remote Control (CDP-XE570/XE370 only)	6

Getting Started

Inserting Batteries Into the Remote Control (CDP-XE570/XE370 only)	7
Hooking Up the System	7

Playing CDs

Loading the CD	8
Playing the CD — Normal Play/Shuffle Play/Repeat Play	9
Using the CD display	10
Repeating a Specific Portion (A↔B Repeat) (CDP-XE570 only)	11
Programming the CD tracks	12
Fading In or Out (CDP-XE570/XE370 only)	13

Recording From CDs (CDP-XE570 only)

Recording a CD by Specifying Tape Length (Time Edit)	13
Adjusting the Recording Level (Peak Search)	14

Additional Information

Using the CONTROL A1II control system (CDP-XE570 only)	15
Precautions	17
Notes on CDs	17
Troubleshooting	18
Specifications	18

Front Panel

The items are arranged in alphabetical order.

Refer to the pages indicated in parentheses () for details.

CDP-XE570

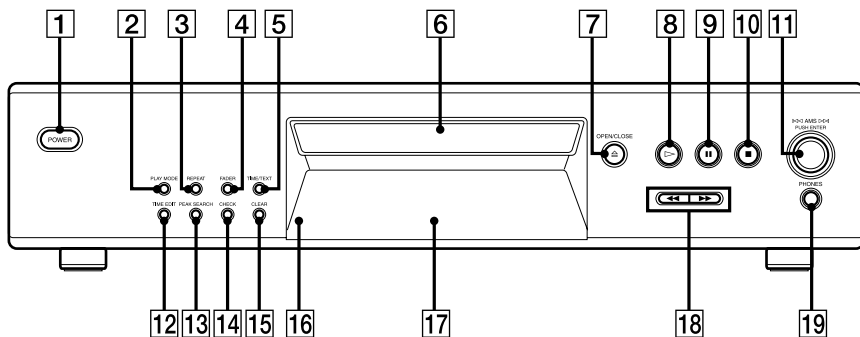

CDP-XE370/XE270

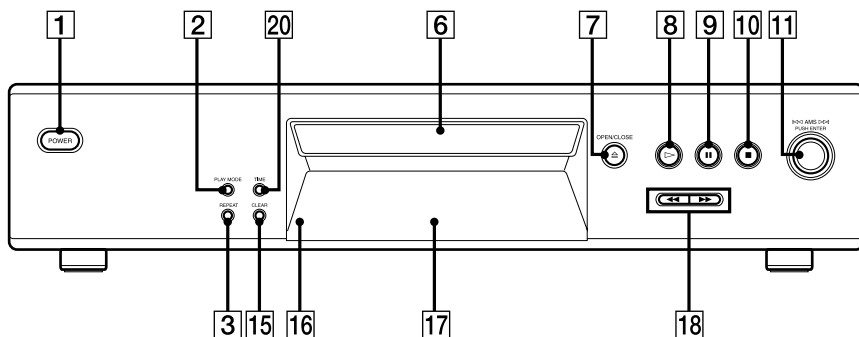

- CHECK **14** (12)
- CLEAR **15** (12)
- Disc compartment **6** (8)
- Display **17** (10)
- FADER **4** (13)
- PEAK SEARCH **13** (14)
- PHONES jack **19** (9)
- PLAY MODE **2** (9, 12, 14)
- POWER **1** (8)
- Remote sensor **16** (7)
(CDP-XE570/XE370 only)
- REPEAT **3** (9, 11)
- TIME **20** (10)
- TIME EDIT **12** (13, 14)
- TIME/TEXT **5** (10)

BUTTON DESCRIPTIONS

- ⏪ OPEN/CLOSE **7** (8, 10, 12)
- ▶ **8** (9, 11, 12, 14)
- ⏸ **9** (9, 14)
- **10** (9, 14)
- ◀◀AMS▶▶ dial **11** (9, 12, 14)
- ◀◀▶▶ **18** (9, 13)

Rear Panel

CDP-XE570

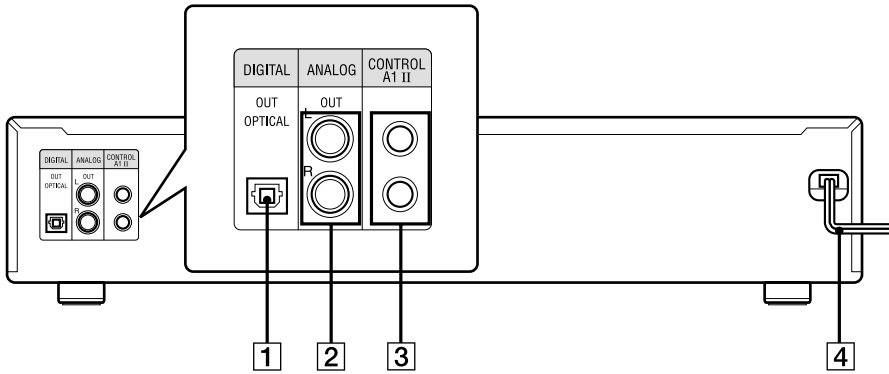

CDP-XE370/XE270

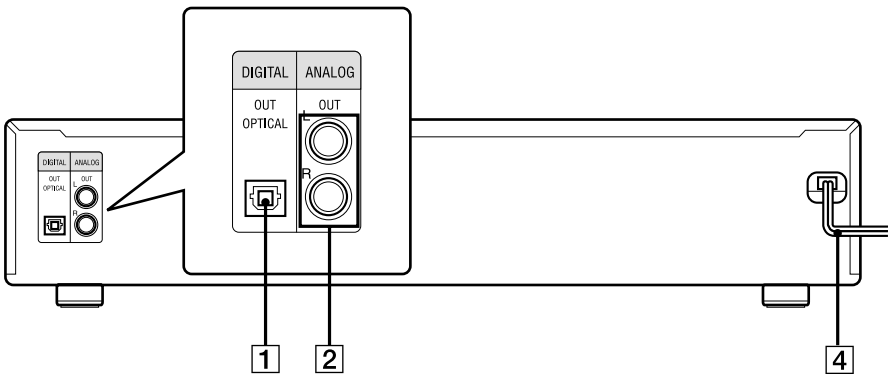

- ANALOG OUT L/R jacks **2** (7)
- CONTROL A1II jacks **3** (8, 15)
- DIGITAL OUT OPTICAL jack **1** (8)
- Mains lead **4** (7)

Remote Control (CDP-XE570/XE370 only)

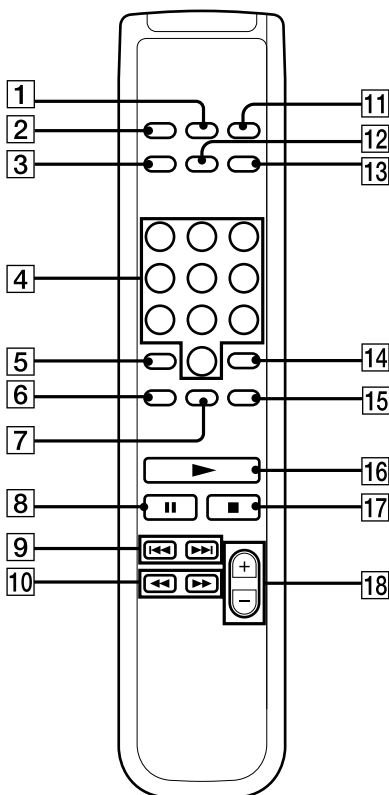

- A↔B **7** (11) (CDP-XE570 only)
- ANALOG OUT LEVEL +/- **18** (7, 9)
- CHECK **15** (12)
- CLEAR **14** (12)
- CONTINUE **2** (9, 14)
- DISPLAY ON/OFF **12** (11)
- FADER **13** (13)
- Number buttons **4** (9, 12)
- PROGRAM **11** (9)
- REPEAT **6** (9)
- SHUFFLE **1** (9)
- TIME **3** (10)

BUTTON DESCRIPTIONS

- >10 **5** (9, 12)
- ▶ **16** (9, 11, 12, 14)
- || **8** (9, 14)
- **17** (9, 14)
- ◀◀ AMS ▶▶ **9** (9, 12, 14)
- ◀◀/▶▶ **10** (9, 13)

Inserting Batteries Into the Remote Control (CDP-XE570/XE370 only)

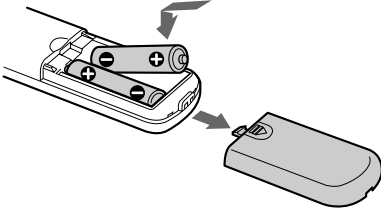

You can control the player using the supplied remote.

Insert two R6 (size AA) batteries by matching the + and - on the batteries to the diagram inside the battery compartment.

Insert the negative (-) end first, then push in and down until the positive (+) end clicks into position.

When using the remote, point it at the remote sensor  on the player.

Tip

When the remote no longer operates the system, replace both batteries with new ones.

Note

- Do not leave the remote near an extremely hot or humid place.
- Do not drop any foreign object into the remote casing, particularly when replacing the batteries.
- Do not expose the remote sensor to direct sunlight or lighting apparatuses. Doing so may cause a malfunction.
- If you don't use the remote for an extended period of time, remove the batteries to avoid possible damage from battery leakage and corrosion.

Hooking Up the System

Hookups

This section describes how to hook up the CD player to an amplifier. Be sure to turn off the power of each component before making the connections.

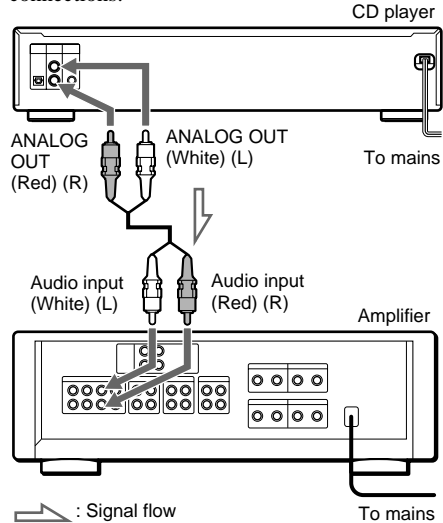

Tip (CDP-XE570/XE370 only)

You can adjust the analog output level to the amplifier using the remote comes with this player. Press ANALOG OUT LEVEL +/- on the remote. You can reduce the analog output level up to -20 dB. When you reduce the analog output level, "FADE" (or  for the CDP-XE370) appears in the display. When you turn off the player, the output level automatically returns to the maximum level.

Setting the voltage selector (voltage selector equipped models only)

Check that the voltage selector on the rear panel of the player is set to the local power line voltage. If not, set the selector to the correct position using a screwdriver before connecting the AC power cord to a wall outlet.

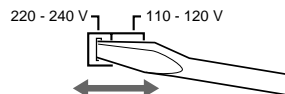

Hooking Up the System (continued)

Making digital hookups

If you have a digital component such as a digital amplifier, D/A converter, DAT, or MD, connect the component via the DIGITAL OUT (OPTICAL) connector using the optical cable (not supplied). Take off the cap and plug in the optical cable.

Note that you cannot use the following functions when making this connection:

- Fading In or Out (CDP-XE570/XE370 only) (see page 13)
- Adjusting the output level using the ANALOG OUT LEVEL +/- buttons on the remote (CDP-XE570/XE370 only)

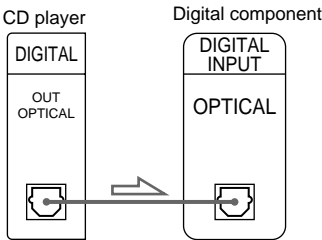
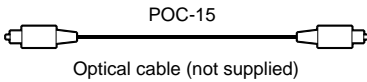

Note

When you connect via the DIGITAL OUT (OPTICAL) connector, noise may occur when you play CD software other than music, such as a CD-ROM.

Tip (CDP-XE570 only)

If you have a Sony component with the CONTROL AIII jack, connect the component via the CONTROL AIII jack. You can simplify the operation of audio systems composed of separate Sony components. For details, see "Using the CONTROL AIII control system" on page 15.

Loading a CD

- 1 Turn on the amplifier and select the CD player position so that you can listen to the sound from this player.
- 2 Press POWER to turn on the player.
- 3 Press \triangle OPEN/CLOSE.
The disc compartment slides out.
- 4 Place a disc on the disc tray with the label side up.

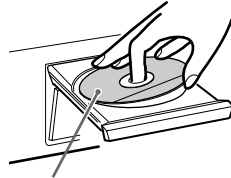

When you play a CD single, place it on the inner circle of the tray.

- 5 Press \triangle OPEN/CLOSE to close the disc compartment.

Playing the CD

—Normal Play/Shuffle Play/Repeat Play

This unit lets you play the CD in different play modes.

1 Press **PLAY MODE** repeatedly until the mode you want appears.

Select	To play
CONTINUE	The CD in the original order.
SHUFFLE	The tracks on the CD in random order.
PROGRAM	The tracks on the CD in the order you want them to be played (see "Programming the CD tracks" on page 12).

2 Press **▷**.

Tip (CDP-XE570/XE370 only)

You can select the playing mode by pressing CONTINUE, SHUFFLE, or PROGRAM on the remote.

Repeat Play Operations

You can play the CD tracks repeatedly in any play modes.

To activate the Repeat Play function, press REPEAT until "REPEAT" appears in the display.

To	Press REPEAT
Repeat only one track	Until "REPEAT 1" appears while playing the track you want to repeat.
Cancel Repeat Play	Until "REPEAT" or "REPEAT1" disappears.

When you are in the Repeat Play function, the player repeats the tracks as follows:

When the disc is played in	The player repeats
Continuous Play	All the tracks
Shuffle Play	All the tracks in random order
Programme Play (page 12)	The same programme

Other Operations

To	Do this
Stop playback	Press ■ .
Pause	Press ⏸ . Press ⏸ again or ▷ to resume play.
Select a track	During play or pause, turn ⏮ clockwise (to go forward) or ⏭ counterclockwise (to go backward) (or press ▶▶ (to go forward) or ◀◀ (to go backward) on the remote (CDP-XE570/XE370 only)).
Select a track directly	Press the number button on the remote.*
Find a point in a track	Press and hold ▶▶ or ◀◀ during playback, and release at the desired point.
Play tracks in random order	Press PLAY MODE until "SHUFFLE" appears in the display.
Remove the CD	Press ⏏ OPEN/CLOSE.
Adjust the volume	Press ANALOG OUT LEVEL +/- on the remote.

* When you directly locate a track numbered over 10, press >10 first, then the corresponding number buttons. To enter "0," use button 10.

Example: To play track number 30
Press >10 first, then 3 and 10.

Tips

- You can adjust the analog output level with the **ANALOG OUT LEVEL +/-** on the remote (page 7) (CDP-XE570/XE370 only).
- You can adjust the headphones volume on the remote. To adjust the volume, connect the headphones to the PHONES jack and adjust the volume with the **ANALOG OUT LEVEL +/-** on the remote (CDP-XE570 only).
- If there is no CD in the player, "–NO DISC–" (or "no DISC" for the CDP-XE370/XE270) appears in the display.

Note

If "– OVER –" (or "⏮ ⏮" for the CDP-XE370/XE270) appears in the display, the disc has reached the end while you were pressing **▶▶**. Press **◀◀** or turn **⏮** counterclockwise to go back.

Using the CD display

You can check information about the disc using the display.

In the stop mode

Press TIME/TEXT (or TIME for the CDP-XE370/XE270).

CDP-XE570

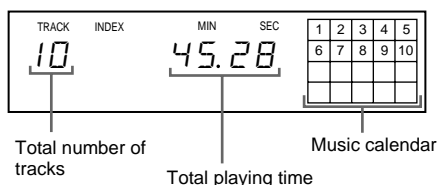

CDP-XE370/XE270

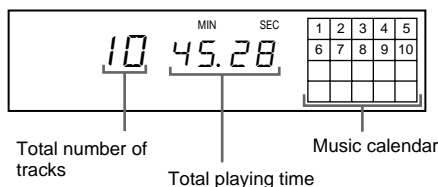

The display shows the total number of tracks, total playing time, and music calendar.

While in Shuffle Play mode (“SHUFFLE” appears in the display; see page 9), a one-second access time blank is added between each track. This increase is automatically added to the total playing time in the display.

The information also appears when you press \equiv OPEN/CLOSE to close the disc tray.

During normal playback

While playing a disc, the display shows the current track number, playing time, and the music calendar.

The track numbers in the music calendar disappear after they are played.

To check the remaining time

Press TIME/TEXT (or TIME for the CDP-XE370/XE270) during playback.

Each time you press this button while playing a disc, the display changes as shown in the chart below.

Playing time on the current track →

Remaining time on the current track →

Remaining time on the disc

Notes

- If the track number exceeds 25, “- - -” appears instead of the remaining time on the current track.
- When the disc has more than 25 tracks in Shuffle or Programme Play, “- - -” appears instead of the remaining time.

While playing a CD TEXT disc (CDP-XE570 only)

CD TEXT discs have information, such as the disc titles or artist names, memorised in a blank space on the discs where, on normal discs, there is no information. The display shows the CD TEXT information of the disc so that you can check the current disc title, artist name, and track title. When the player detects CD TEXT discs, the “CD TEXT” indication appears in the display.

In the Stop Mode

Press TIME/TEXT.

Each time you press this button, the display changes as shown in the chart below.

Disc title → Artist name → Total number of tracks and total playing time

During normal playback

Press TIME/TEXT.

Each time you press this button, the display changes as shown in the chart below.

Track title → Playing time on the current disc
→ Remaining time on the current track →
Remaining time on the disc

If a title or name has more than 12 characters, the first 12 characters will light up after the title or name scrolls by in the display.

Notes

- If the track number exceeds 25, “-- . --” appears instead of the remaining time on the current track.
- When the disc has more than 25 tracks in Shuffle or Programme Play, “-- . --” appears instead of the remaining time.
- The display may not show all the characters depending on the disc.
- This player can only display the disc titles, track titles and artist names from CD TEXT discs. Other information cannot be displayed.

Turning off indications in the display (CDP-XE570/XE370 only)

Press DISPLAY ON/OFF on the remote.

Each time you press this button while playing a disc, the display turns off and on alternately.

Even when the display is turned off, the display turns on if you pause or stop play. When you resume play, the display turns off again.

Before you start playing, when you press DISPLAY ON/OFF to turn off the display, “DISPLAY OFF” (or “d-OFF” for the CDP-XE370) appears, and when you press the button to turn on the display, “DISPLAY ON” (or “d-ON” for the CDP-XE370) appears.

Repeating a Specific Portion (A↔B Repeat) (CDP-XE570 only)

You can play a specific portion in a track repeatedly. This might be useful when you want to memorise lyrics.

Note that you cannot repeat a portion extending to two tracks.

1 While playing a disc, press A ↔ B on the remote when you find the starting point (point A) to be played repeatedly.

“A-” of “REPEAT A-” flashes in the display.

2 When you reach the ending point (point B), press A ↔ B again.

“REPEAT A-B” appears. The player plays this specific portion repeatedly.

To cancel A↔B Repeat
Press REPEAT.

Setting a new starting point

When you press A ↔ B during A↔B Repeat Play, the ending point B becomes the new starting point (point A). Then press A ↔ B again when you reach the ending point (new ending point B).

“REPEAT A-B” appears and the player repeats between the new starting and ending points.

Tip

When you want to restart from the starting point A, press ▷ during A↔B Repeat.

Programming the CD tracks

You can arrange the order of the tracks on a disc and create your own programme. The programme can contain up to 24 tracks.

- 1 Press **PLAY MODE** repeatedly until **"PROGRAM"** appears in the display before you start playing.
- 2 Turn **⏪⏩AMS⏪⏩** until the track you want appears and push **⏪⏩AMS⏪⏩** to select the track.
The track number that you programmed, the playing order, and the total playing time appear in the display.
If you've made a mistake
Press **CLEAR**, then repeat Step 2.
Tip (CDP-XE570/XE370 only)
You can select the track using the number buttons on the remote. To select a track with a number over 10, use >10 (see page 9).
- 3 Repeat Step 2 to programme the tracks in the order you want.
- 4 Press **▷** to start Programme Play.

To cancel Programme Play
Press **PLAY MODE**.

Tips

- The programme remains until erased or until you press **⏏** OPEN/CLOSE. The programme you have created remains even after the Programme Play mode ends or you select another play mode.
- For the recording to the A side or B side of the cassette tape, you can pause Programme Play.

Notes

- The total playing time doesn't appear in the display when it exceeds 100 minutes.
- If you programme a track numbered over 24 (or 68 for the CDP-XE370/XE270), "--. --" appears instead of the total playing time.
- "PROGRAM FULL" (or "FULL" for the CDP-XE370/XE270) appears in the display when you try to add a track to a programme which already contains 24 tracks.

Checking the track order (CDP-XE570/XE370 only)

You can check your programme before or after you start playing.

Press CHECK.

Each time you press this button, the display shows the track number in the programmed order. After the last track in the programme, the display shows "- END -" (or "End" for CDP-XE370) and returns to the original display. If you check the order after you start playing, the display shows only the remaining track numbers.

Changing the track order





You can change your programme before you start playing.

To	You need to
Erase a track	Press CHECK until the track you don't want appears in the display, then press CLEAR (CDP-XE570/XE370 only).
Erase the last track in the programme	Press CLEAR . Each time you press the button, the last track will be cleared.
Add tracks to the end of the programme	Turn ⏪⏩AMS⏪⏩ until the track number you want to add appears, then push ⏪⏩AMS⏪⏩ . When using the remote, press the number buttons of the tracks to be added (CDP -XE570/XE370 only).
Change the whole programme completely	Hold down CLEAR until "CLEAR" (for the CDP-XE570) or "CLEAR" (for the CDP-XE370/XE270) appears in the display. Create a new programme following the programming procedure.

Fading In or Out (CDP-XE570/XE370 only)

You can manually fade in or out to prevent tracks from starting or ending abruptly.

Note that you cannot use this effect when you use the DIGITAL OUT (OPTICAL) connector.

To	Press FADER
Start play fading in	During pause. For the CDP-XE570, "FADE" flashes. For the CDP-XE370,  lights up in the display and the  indication flashes. The play fades in.
End play fading out	When you want to start fading out. For the CDP-XE570, "FADE" flashes. For the CDP-XE370,  lights up in the display and the  indication flashes. Then play fades out and the player pauses.

Fading time lasts for 5 seconds.

Recording a CD by Specifying Tape Length (Time Edit)

You can have the player create a programme that will match the length of the tape. In this feature, the player creates a programme basically keeping the original order of the disc. However, the player may change the last track of each side to match the recording time to the tape length.

i.e. Side A: track number 1→2→3→4→8
Side B: track number 5→6→7→9→10

The programme may contain up to 24 tracks (a pause inserted between tracks is counted as one track).

Note that tracks numbered over 24 cannot be programmed in this feature.

- 1 Press **TIME EDIT** before you start playing until "EDIT" appears and "TAPE A" flashes in the display.
- 2 Press **◀** or **▶** to specify the tape length.

Each time you press these buttons, the display changes as shown below with the tape length of one side .

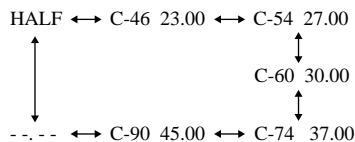

When you select "HALF"

The player divides the total playing time of the disc in half, keeping the original order.

Note that you cannot select "HALF" when the disc has more than 24 tracks.

continued

Recording a CD by Specifying Tape Length (Time Edit) (continued)

- 3 Press **TIME EDIT** to have the player create the programme.

The display shows the tracks to be recorded. "TAPE B" flashes in the display.

- 4 When you record on both sides of the tape, press **TIME EDIT** again.

The player inserts a pause, then creates the programme for side B. The display shows the programmed tracks.

When you record on one side of the tape or on a DAT or MD, skip this step.

- 5 Start recording on the deck and then press **▷** on the player.

When you record on both sides of the tape, the player pauses at the end of the programme for side A.

- 6 Reverse the tape to side B and press **▷** or **II** on the player to resume playing the remaining tracks.

To cancel Time Edit

Press **PLAY MODE**.

When using the remote, press **CONTINUE**.

Tips

- You can set the tape length freely using **II<< AMS >>II**.
Example: When the tape length of one side is 30 minutes and 15 seconds
 - 1 To set the minutes, turn **II<< AMS >>II** until "30" appears in the display, then push **II<< AMS >>II**.
 - 2 To set the seconds, turn **II<< AMS >>II** until "15" appears in the display, then push **II<< AMS >>II**.
- To check and change your programme, see page 12.

Adjusting the Recording Level (Peak Search)

The player locates the highest level among the tracks to be recorded to let you adjust the recording level before you start recording.

- 1 Before you start playing, press **PEAK SEARCH**.

"PEAK" flashes in the display and the player starts scanning the disc searching for the highest peak level.

After scanning all the tracks, the player repeats the portion with the highest peak level.

- 2 Adjust the recording level on the deck.

- 3 Press **■** on the player to stop Peak Search.

"PEAK" disappears from the display.

Note

The portion with the highest level may differ every time you try the adjustment on the same disc. The difference is, however, so slight that you won't find any problem in adjusting the recording level precisely.

Using the CONTROL A1II control system (CDP-XE570 only)

This player is compatible with the CONTROL A1II Control System.

The CONTROL A1II control system was designed to simplify the operation of audio systems composed of separate Sony components. CONTROL A1II connections provide a path for the transmission of control signals that enable automatic operation and control features usually associated with integrated systems.

Currently, CONTROL A1II connections between a Sony MD deck, CD player, amplifier (receiver), and cassette deck provide automatic function selection and synchronized recording.

In the future the CONTROL A1II connection will work as a multifunction bus allowing you to control various functions for each component.

Note

The CONTROL A1II control system is designed to maintain upward compatibility as the control system is upgraded to handle new functions. In this case, however, older components will not be compatible with the new functions.

CONTROL A1II and CONTROL A1 compatibility

The CONTROL A1 control system has been updated to the CONTROL A1II which is the standard system in the Sony 300 disc CD changer and other recent Sony components. Components with CONTROL A1 jacks are compatible with components with CONTROL A1II, and can be connected to each other. Basically, the majority of the functions available with the CONTROL A1 control system will be available with the CONTROL A1II control system. However, when making connections between components with CONTROL A1 jacks and components with CONTROL A1II jacks, the number of functions that can be controlled may be limited depending on the component. For detailed information, refer to the operating instructions supplied with the component(s).

Connecting the CONTROL A1II control system

Connect monaural (2P) mini-plug cables in series to the CONTROL A1II jacks on the back of each component. You can connect up to ten CONTROL A1II compatible components in any order. However, you can connect only one of each type of component (i.e., 1 CD player, 1 MD deck, 1 tape deck and 1 receiver). (You may be able to connect more than one CD player or MD deck, depending on the model. Refer to the operating instructions supplied with the respective component for details.)

Example

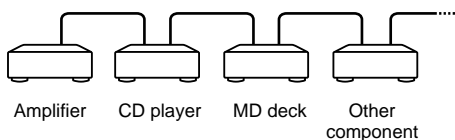

continued

Using the CONTROL A1II control system (CDP-XE570 only) (continued)

In the CONTROL A1II control system, the control signals flow both ways, so there is no distinction of IN and OUT jacks. If a component has more than one CONTROL A1II jack, you can use either one, or connect different components to each jack.

About the connecting cable
When a CONTROL A1II compatible component is not supplied with a connecting cable, use a commercially available monaural (2P) mini-plug cable less than 2 meters (6.6 feet) long, with no resistance (such as the Sony RK-G69HG).

Basic functions of the CONTROL A1II control system

Automatic function selection

When you connect CONTROL A1II compatible Sony components using CONTROL A1II cables (not supplied), the function selector on the amplifier (or receiver) automatically switches to the correct input when you press the play button on one of the connected components.

(For example, when you press \blacktriangleright (play button) on the CD while the MD deck is playing, the function selector on the amplifier switches from MD to CD.)

Notes

- This function works only when the components are connected to the amplifier (or receiver) inputs according to the names on the function buttons. Certain receivers allow you to switch the names of the function buttons. In this case, refer to the operating instructions supplied with the receiver.
- When recording, do not play any components other than the recording source. It will cause the automatic function selection to operate.

Synchronized recording

This function lets you conduct synchronized recording between the CD and the recording component.

- 1 Set the source selector on the amplifier (or receiver) to the CD.**
- 2 Set the CD to playing pause mode (make sure both the \blacktriangleright and **II** indicators light together).**
- 3 Set the recording component to recording pause mode.**
- 4 Press **II** on the deck.**

The CD is automatically released from pause mode, and recording begins shortly thereafter.

When play ends from the CD, recording stops.

Tip

Certain recorder components may be equipped with a special synchronized recording function that uses the CONTROL A1II Control System; like "CD Synchro Dubbing." In this case, refer to the Operating Instructions supplied with the recorder component.

Note

Do not set more than one component to the pause mode.

Precautions

On safety

- Caution — The use of optical instruments with this product will increase eye hazard.
- Should any solid object or liquid fall into the cabinet, unplug the player and have it checked by qualified personnel before operating it any further.
- Discs with non-standard shapes (e.g., heart, square, star) cannot be played on this unit. Attempting to do so may damage the unit. Do not use such discs.

On power sources

- Before operating the player, check that the operating voltage of the player is identical with your local power supply. The operating voltage is indicated on the nameplate at the rear of the player.
- The player is not disconnected from the AC power source (mains) as long as it is connected to the wall outlet, even if the player itself has been turned off.
- If you are not going to use the player for a long time, be sure to disconnect the player from the wall outlet. To disconnect the AC power cord (mains lead), grasp the plug itself; never pull the cord.
- AC power cord must be changed only at the qualified service shop.

On placement

- Place the player in a location with adequate ventilation to prevent heat build-up in the player.
- Do not place the player on a soft surface such as a rug that might block the ventilation holes on the bottom.
- Do not place the player in a location near heat sources, or in a place subject to direct sunlight, excessive dust or mechanical shock.

On operation

- If the player is brought directly from a cold to a warm location, or is placed in a very damp room, moisture may condense on the lenses inside the player. Should this occur, the player may not operate properly. In this case, remove the disc and leave the player turned on for about an hour until the moisture evaporates.

On adjusting volume

- Do not turn up the volume while listening to a portion with very low level inputs or no audio signals. If you do, the speakers may be damaged when a peak level portion is played.

On cleaning

- Clean the cabinet, panel and controls with a soft cloth slightly moistened with a mild detergent solution. Do not use any type of abrasive pad, scouring powder, or solvent such as alcohol or benzene.

If you have any questions or problems concerning your player, please consult your nearest Sony dealer.

Notes on CDs

On handling CDs

- To keep the disc clean, handle the disc by its edge. Do not touch the surface.
- Do not stick paper or tape on the disc.



- Do not expose the disc to direct sunlight or heat sources such as hot air ducts, nor leave it in a car parked in direct sunlight as there can be considerable rise in temperature inside the car.
- Do not use any commercially available stabilizer. If you do, the disc and the player may be damaged.
- After playing, store the disc in its case.

On cleaning

- Before playing, clean the disc with a cleaning cloth. Wipe the disc from the centre out.

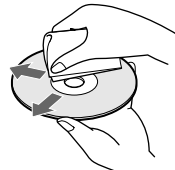

- Do not use solvents such as benzene, thinner, commercially available cleaners or anti-static spray intended for vinyl LPs.

Notes on CD-R/CD-RW playback

- Discs recorded on CD-R/CD-RW drives may not be played back because of scratches, dirt, recording condition, or the drive's characteristics. Besides, the discs, which are not yet finalized at the end of recording, cannot be played back.

Troubleshooting

If you experience any of the following difficulties while using the player, use this troubleshooting guide to help you remedy the problem. Should any problem persist, consult your nearest Sony dealer.

There's no sound.

- Check that the player is connected securely.
- Make sure you operate the amplifier correctly.
- Adjust the analog output level with ANALOG OUT LEVEL +/- on the remote (CDP-XE570/XE370 only).

The CD does not play.

- There's no CD inside the player. "– NO DISC –" (or "no dISC" for the CDP-XE370/XE270) appears. Insert a CD.
- Place the CD with the label side up on the disc tray correctly.
- Clean the CD (see page 17).
- Moisture has condensed inside the player. Remove the disc and leave the player turned on for about an hour.

The recording level has changed.

- The recording level changes if you adjust the analog output level with ANALOG OUT LEVEL +/- on the remote during recording (CDP-XE570/XE370 only).

The remote does not function (CDP-XE570/XE370 only).

- Remove the obstacles in the path of the remote and the player.
- Point the remote at the remote sensor  on the player.
- Replace all the batteries in the remote with new ones if they are weak.

Specifications

Compact disc player

Laser	Semiconductor laser ($\lambda = 780 \text{ nm}$) Emission duration: continuous
Frequency response	2 Hz to 20 kHz $\pm 0.5 \text{ dB}$
Dynamic range	More than 93 dB
Harmonic distortion	0.0045%

Outputs

	Jack type	Maximum output level	Load impedance
ANALOG OUT	Phono jacks	2 V (at 50 kilohms)	Over 10 kilohms
DIGITAL OUT (OPTICAL)	Optical output connector	-18 dBm	Wave length: 660 nm
PHONES (CDP-XE570 only)	Stereo phone jack	10 mW	32 ohms

General

Power requirements

Where purchased Power requirements

USA	120 V AC, 60 Hz
Europe	230 V AC, 50/60 Hz
Australia	240 V AC, 50/60 Hz
Some Asian countries	220 V – 230 V AC, 50/60 Hz

Power consumption	11 W
Dimensions (approx.) (w/h/d)	430 x 95 x 290 mm (17 x 3 3/4 x 11 1/2 in.) incl. projecting parts
Mass (approx.)	CDP-XE570: 3 3 kg (7 lbs 5 oz) CDP-XE370: 3 2 kg (7 lbs 1 oz) CDP-XE270: 3 2 kg (7 lbs 1 oz)

Supplied accessories

Audio cord (2 phono plugs – 2 phono plugs) (1)
Remote commander (remote) (1) (CDP-XE570/XE370 only)
R6 (size AA) batteries (2) (CDP-XE570/XE370 only)

Design and specifications are subject to change without notice.

